

Id.-Nr. 291 698-03

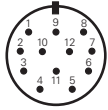

Id.-Nr. 291 698-08

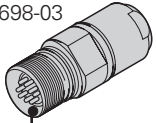
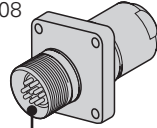

5	6	8	1	3	4	Schirm Shield blindage schermo blindaje	12	10	2	11
A		B		R			5 V Up	0 V Un	5 V sensor	0 V sensor
+	-	+	-	+	-					
braun brown brun marrone marrón	grün green vert verde	grau gray gris	rosa pink rose rosa rosa	rot red rouge rosso rojo	schwarz black noir nero negro		braun/grün brown/green brun/vert marrone/verde marrón/verde	weiß/grün white/green blanc/vert bianco/verde blanco/verde	blau blue bleu azzurro azul	weiß white blanc bianco blanco

IEC 742 EN 50 178

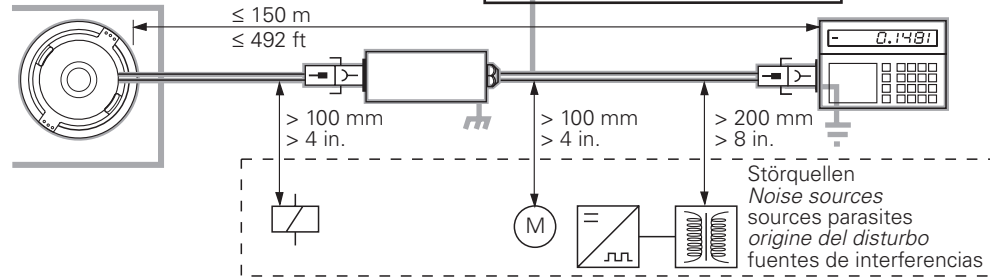

ERN 180.M263

Montageanleitung Mounting Instructions Instructions de montage Istruzioni di montaggio Instrucciones de montaje

12/96



HEIDENHAIN

DR. JOHANNES HEIDENHAIN GmbH

Dr.-Johannes-Heidenhain-Straße 5

D-83301 Traunreut, Deutschland

☎ (0 86 69) 31-0

FAX (0 86 69) 50 61

e-mail: info@heidenhain.de

☎ **Service** (0 86 69) 31-12 72

☎ TNC-Service (0 86 69) 31-14 46

FAX (0 86 69) 98 99

e-mail: service@heidenhain.de

http://www.heidenhain.de

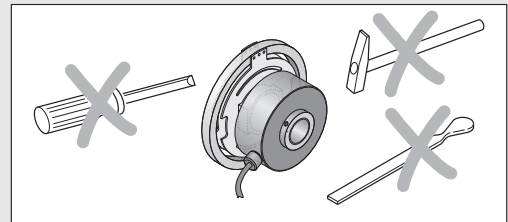
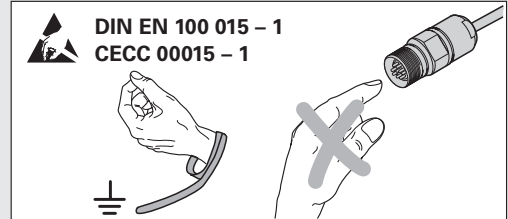
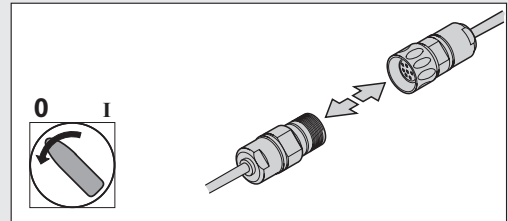

ERN 180.M263

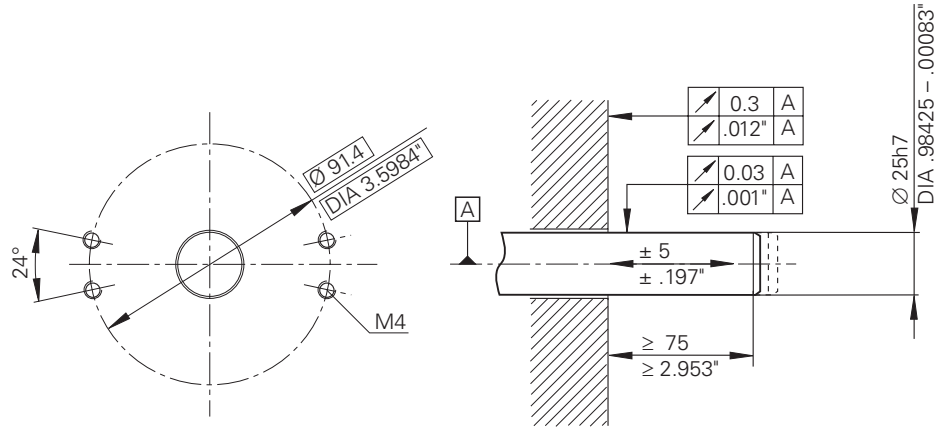

A = Lagerung
 Bearing
 roulement
 cuscinetto
 rodamiento

		 T ≥ -10 °C (14 °F)
Ø 6 mm DIA .236 in.	R ₁ ≥ 20 mm R ₁ ≥ .8 in.	R ₂ ≥ 75 mm R ₂ ≥ 3 in.
Ø 8 mm DIA .315 in.	R ₁ ≥ 40 mm R ₁ ≥ 1.6 in.	R ₂ ≥ 100 mm R ₂ ≥ 4 in.

 °C (°F)	 0 ... 100 °C (32 ... 212 °F)
	 -30 ... 80 °C (-22 ... 176 °F)

